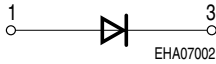
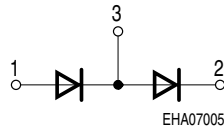
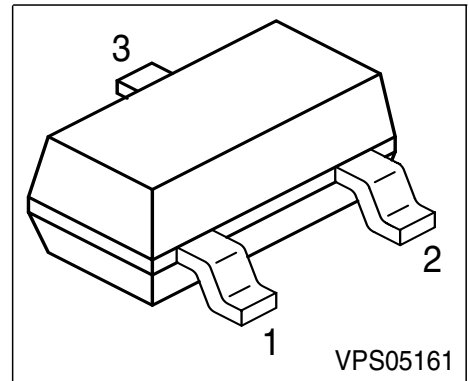
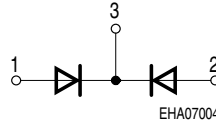
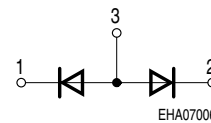

Silicon Schottky Diode

- For mixer applications in VHF/UHF range
- For high-speed switching application

BAT 17

BAT 17-04

BAT 17-05

BAT 17-06

Type	Marking	Pin Configuration			Package
BAT 17	53s	1 = A	2 n.c.	3 = C	SOT-23
BAT 17-04	54s	1 = A1	2 = C2	3 = C1/A2	SOT-23
BAT 17-05	55s	1 = A1	2 = A2	3 = C1/2	SOT-23
BAT 17-06	56s	1 = C1	2 = C2	3 = A1/2	SOT-23

Maximum Ratings

Parameter	Symbol	Value	Unit
Diode reverse voltage	V_R	4	V
Forward current	I_F	130	mA
Total power dissipation $T_S \leq 60^\circ\text{C}$	P_{tot}	150	mW
Junction temperature	T_j	150	°C
Operating temperature range	T_{op}	-55 ... 150	
Storage temperature	T_{stg}	-55 ... 150	

Thermal Resistance

Parameter	Symbol	Value	Unit
Junction - ambient ¹⁾	R_{thJA}	≤ 750	
Junction - soldering point	R_{thJS}	≤ 590	

¹Package mounted on epoxy pcb 40mm x 40mm x 1.5mm / 1cm²

Electrical Characteristics at $T_A = 25^\circ\text{C}$, unless otherwise specified

Parameter	Symbol	Values			Unit
		min.	typ.	max.	
DC Characteristics					
Breakdown voltage $I_{(BR)} = 10 \mu\text{A}$	$V_{(BR)}$	4	-	-	V
Reverse current $V_R = 3$ $V_R = 4 \text{ V}$, $V_R = 3 \text{ V}$, $T_A = 60^\circ\text{C}$	I_R	-	-	0.25 10 1.25	μA
Forward voltage $I_F = 0.1 \text{ mA}$ $I_F = 1 \text{ mA}$ $I_F = 10 \text{ mA}$	V_F	200 250 350	275 340 425	350 450 600	mV
AC Characteristics					
Diode capacitance $V_R = 0 \text{ V}$, $f = 1 \text{ MHz}$	C_T	0.4	0.55	0.75	pF
Forward resistance $I_F = 5 \text{ mA}$, $f = 10 \text{ kHz}$	R_F	-	8	15	Ω

Diode capacitance $C_T = f(V_R)$

$f = 1\text{MHz}$

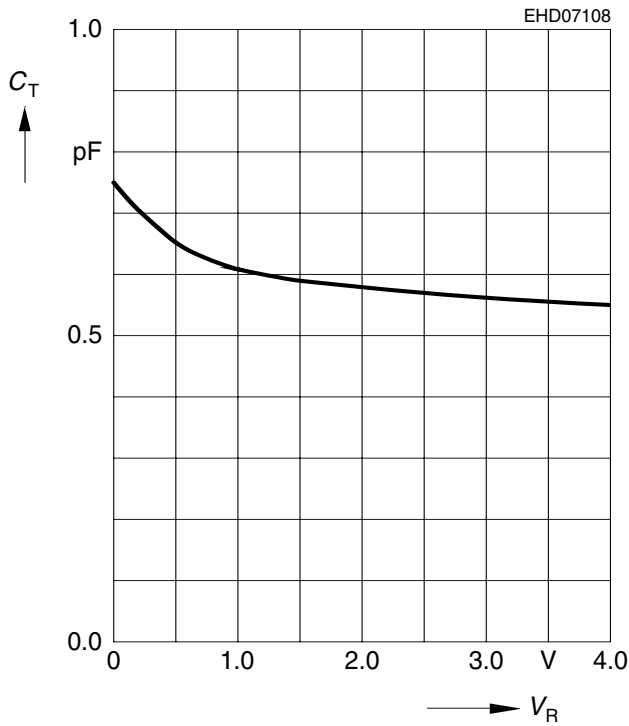

Forward resistance $r_f = f(I_F)$

$f = 10\text{kHz}$

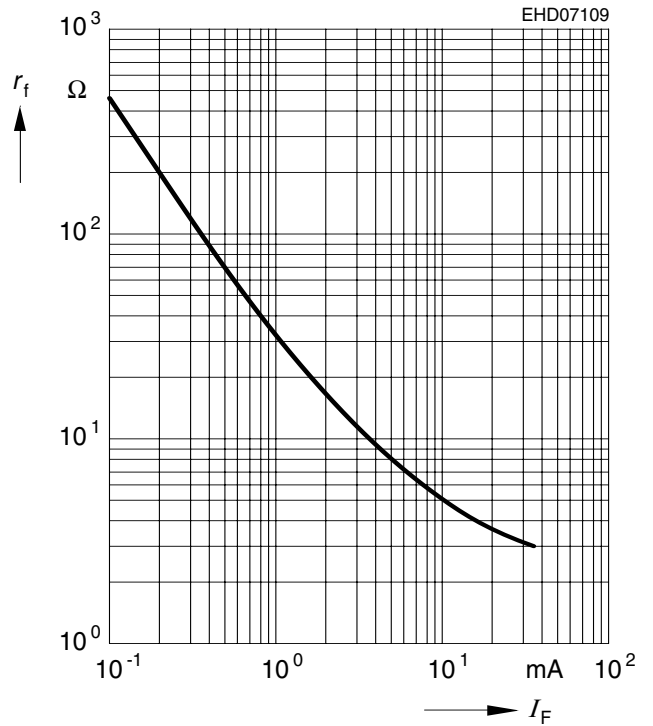

Reverse current $I_R = f(V_R)$

$T_A = \text{Parameter}$

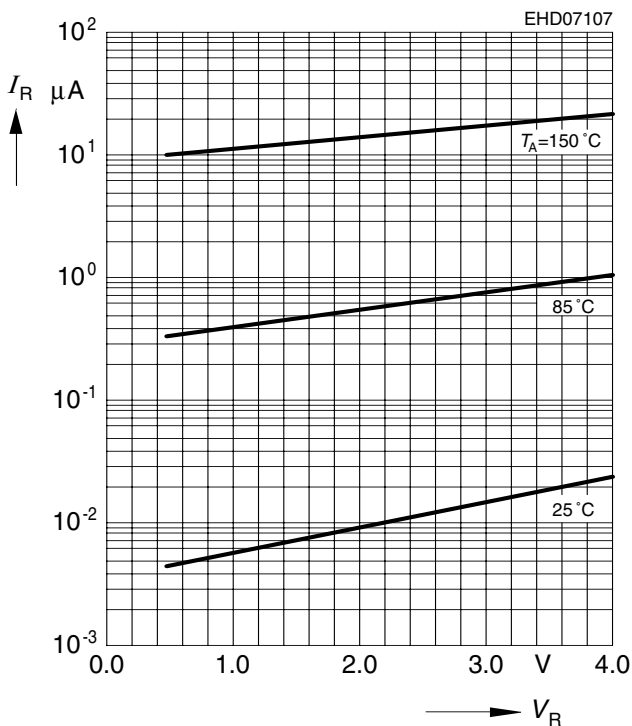

Forward current $I_F = f(T_A^*; T_S)$

* Package mounted on epoxy

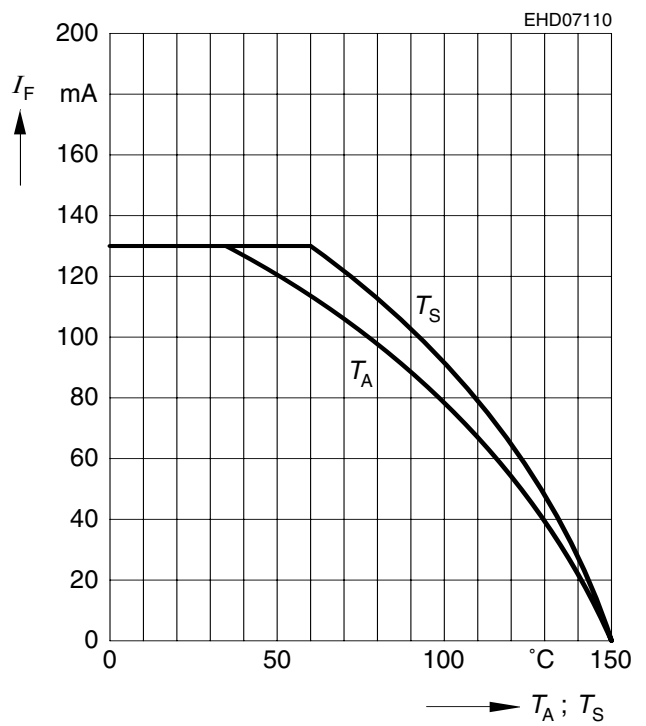

Forward current $I_F = f(V_F)$

$T_A =$ Parameter

